



Freight Car Components & Services Catalog

The most comprehensive portfolio in the industry



Freight Car Components & Services Catalog

Table of Contents

| | | | |
|-----------------------------------|----|---|----|
| Welcome to Wabtec | 4 | End of Car Systems | 28 |
| | | Coupler System | |
| | | Draft Gears | |
| | | Cushioning Units | |
| | | SAC-1™ Spherical Articulated Connector | |
| | | Miscellaneous Components | |
| Braking Systems | 6 | | |
| ABDX® Control Valve | | | |
| Receivers & Access Plates | | | |
| Automated Single Car Test Devices | | | |
| Empty/Load Equipment | | | |
| Valves & Cocks | | | |
| Brake Cylinders & Reservoirs | | | |
| Fittings, Hoses & Couplings | | | |
| Hand Brakes | | | |
| Truck Mounted Brake Systems | | | |
| Slack Adjusters | | | |
| Rigging | | | |
| Brake Shoes | | | |
| ECP | | | |
| Miscellaneous Components | | | |
| Truck Systems | 20 | Specialty Components | 34 |
| Side Frames & Bolsters | | Hatch Cover Systems | |
| Wheels & Axles | | Outlet Gate Systems | |
| Springs | | Car Body Parts & Fabrications | |
| Bearing Adapters & Shear Pads | | Autorack Solutions | |
| Friction Wedges | | Other Freight Car Parts | |
| Side Bearings | | | |
| Wear Prevention | | | |
| Center Plates | | | |
| Miscellaneous Components | | | |
| | | Global Field Services and Repair | 42 |
| | | Component Reconditioning | |
| | | Education & Technical Support | |
| | | Contact Information | 46 |

Welcome to Wabtec

Wabtec is a diversified, global leader in equipment, components, services, software and systems for the transportation industry. Drawing on nearly four centuries of collective experience across Wabtec, GE Transportation and Faiveley Transport, the company is paving the way in safety, efficiency, reliability and productivity.

Freight Car Components and Services Group

Wabtec offers an unmatched offering of freight car products and services. Our reputation for developing advanced braking equipment for freight cars is unsurpassed. No other supplier has more experience or has made more distinguished contributions in improving safety, reliability or productivity.

The primary markets we serve include global railroads, private car owners, OEM car builders, freight car repair and leasing companies.

100+

Countries with Wabtec products and components on freight cars and locomotives

27K

Employees

NYSE

WAB

Corporate Headquarters
PITTSBURGH, PA

Combined Portfolio

23K+

Locomotives in Global Installed Base



~65% Freight



~35% Transit

United by a clear mission

Performance that drives progress.
We create transportation solutions that move and improve the world.

Braking Systems

- ABDX® Control Valve Receivers & Access Plates
- Automated Single Car Test Devices Empty/Load Equipment
- Valves & Cocks Brake Cylinders & Reservoirs
- Fittings, Hoses & Couplings Hand Brakes
- Truck Mounted Brake Systems Slack Adjusters Rigging
- Brake Shoes ECP Miscellaneous Components

Braking Systems

ABDX® Control Valve

In 1869, George Westinghouse, Jr. patented a system that used air pressure to stop trains. Since then, Wabtec has continuously led the industry, improving our brake components to meet car design and operational demands.

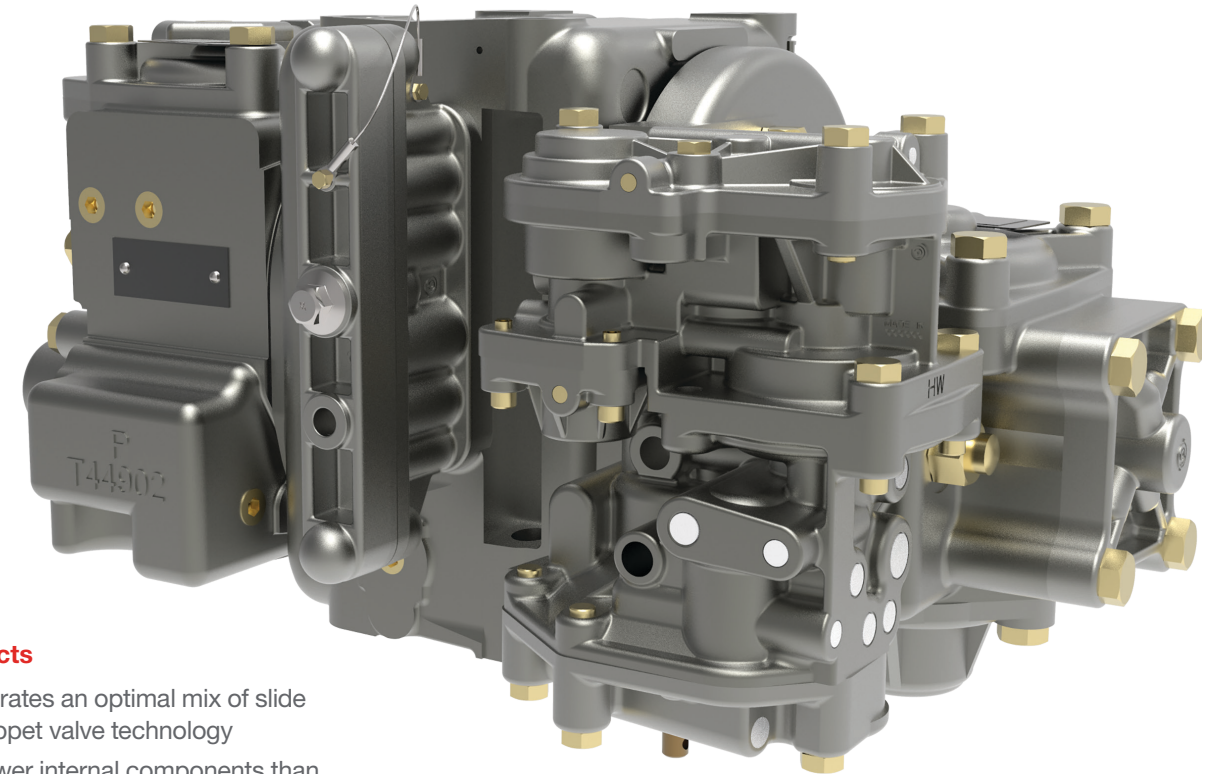

Quick Facts

- Incorporates an optimal mix of slide and poppet valve technology
- 20% fewer internal components than the competition
- Unlike rubber seals, metal-to-metal seal is not adversely affected by low temperature or degradation
- Built-in accommodation available for precise, automatic on-car testing utilizing 4-port testing system

Available Models

- ABDX: standard cars (45 – 75 feet of brake pipe)
- ABDX-L: long cars (>75 feet of brake pipe)
- ABDX-SS: super short cars (<45 feet of brake pipe) (For captive service, not for interchange in North America)

Wabtec’s proven technology and experience deliver dependable, long lasting, quality solutions that assure precise operating performance and proper brake-cylinder pressure under all braking conditions, including the most demanding grade situations.

Wabtec’s continuous improvement efforts have resulted in the enhanced ABDX®, delivering more benefits than ever before. The new design incorporates redesigned main piston diaphragms, upgraded emergency portion slide valves, and service portion graduating valve material.

Metal alloy provides enhanced resistance to fretting wear when exposed to severe vibration.

These changes improve cold weather performance, offer greater resistance to severe vibration, and provide longer service life.

Braking Systems

ABDX[®] Control Valve Optional Features

Brake Cylinder Maintaining (CM)

- Reduces the need to apply heavier brake application to compensate for lower braking effort due to brake cylinder leakage on long grades
- Can assist in sustaining braking effort on cars with leakage from brake cylinder
- May reduce potential set-out by wayside thermal detectors for borderline 'cold-wheel'

Hot Wheel Protection (HW)

- Reduces potential Thermal Mechanical Shelling due to high wheel temperature caused by excessive cylinder pressure
- Reduces potential train stop due to 'hot wheel' or set-out for 'warm-wheel'

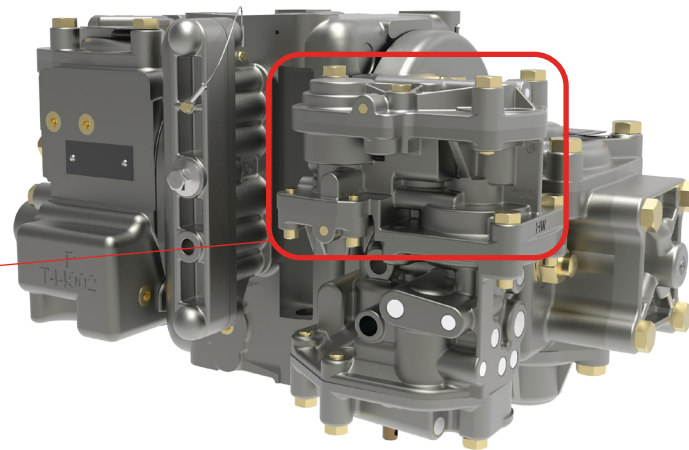

Braking Systems

Receivers & Access Plates

Wabtec offers 4-Port receivers and access plates for application with various pipe bracket mounting arrangements.

Use with the Automated Single Car Test Device to save time and increase accuracy:

- Over 90% of problems are diagnosed in the first 15 minutes of testing
- Average test time is ~ 27 minutes; up to 50% time savings
- Reduces "false failures" due to human error common in manual testing



4-Port Receivers

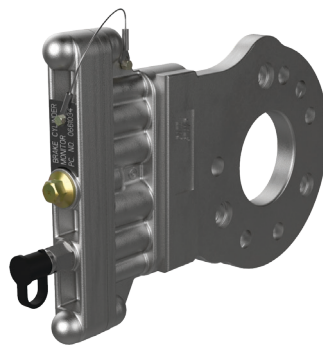

Access Plates

Available Configurations:

- Front
- Top 0°
- Top 90°
- Bottom 15°
- Bottom 45°

Braking Systems

Automated Single Car Test Device

Wabtec's Automated Single Car Test Device (ASCTD) offers significant time and cost savings over manual single car testing. It is approved and compliant to AAR specification S-4027 and is scalable to accommodate future upgrades including ECP testing. Our ASCTD improves the reliability of every car tested.

- Saves time and increases the accuracy of freight car air brake testing; records and displays system leakage and pressure to the tenth of a psi in each of the pressure ports
- Capable of running tests via the conventional end-of-car method or with the Wabtec 4-Port receiver system which provides better testing results in half the time
- Display options include a Windows-based user interface with 10" touchscreen or out-of-the-box Wi-Fi capability for end users to connect wirelessly and interface with the device using their specific hardware/display
- Documented test results provide an irrefutable record of compliance while reducing costly misdiagnosis and the erroneous removal of properly functioning valve portions



Cart Mount



Truck Mount

Accessories



ASCTD Calibration Kit

- Available for purchase to maintain ASCTD calibration as required



Rough Service Brake Cylinder Hose

- 50' hose
- Available on hose reel or separately



End of Car Hose

- Optional 14' or 20' hose
- Detachable



Wireless Transducer

- Eliminates the need for brake cylinder pressure hose

Braking Systems

Empty/Load Equipment

ELX Type

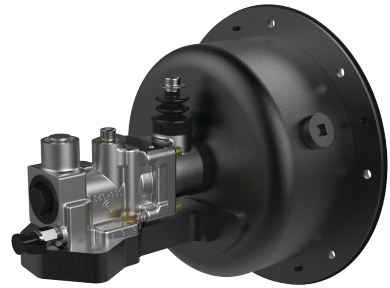

ELX-S

- Self-contained unit mounts to slope sheet
- Diaphragm actuated, integral equalizing volume
- Includes self resetting lock-out button that simplifies single car testing while ensuring the device automatically resets when the brake pipe is recharged
- Available with optional food grade (FDA) diaphragm and Brake Cylinder Read Device

ELX-B

- Sensor arm measures relationship of car body to top of truck side frame to determine if a car is empty or loaded
- Requires detached equalizing volume
- Lightweight and compact design
- Easy setup and adjustment
- Options include Brake Cylinder Read Device and 4" adjusting screw (3" adjusting screw is standard)
- Available in low profile version for installations with limited height clearance

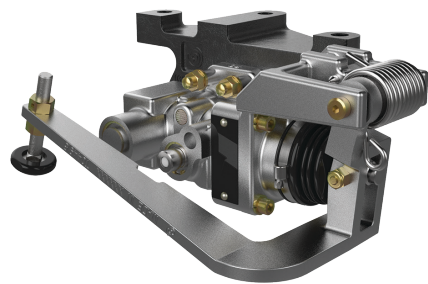

SC-1 Type



S-1 Load Sensing Valve

- Sensor arm measures relationship of car body to top of truck side frame to determine if a car is empty or loaded
- Regulates air flow to the P-1 Load Proportional Valve when a car is empty



S-3 Load Sensing Valve

- Sensor arm measures relationship of car body to top of truck side frame to determine if a car is empty or loaded
- Regulates air flow to the P-1 Load Proportional Valve when a car is empty

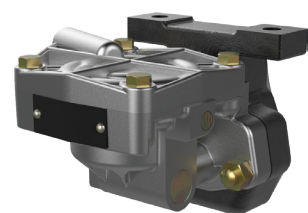

P-1 Load Proportioning Valve

- Proportions brake cylinder pressure on an empty car at either 40%, 50% or 60% of a loaded car



Equalizing Reservoir

- Small reservoir provides a pressure balance with the brake cylinder upon an empty car brake application
- Reservoir is sized to match the proportioning ratio of the empty/load device

Braking Systems

Valves & Cocks



Retaining Valves

- Three-position, manually operated valve allows either direct air flow from brake cylinder on a brake release or retains air in brake cylinder on a release, depending on the position of the handle
- Available in brass or composite
- Floor and suspension mounting options

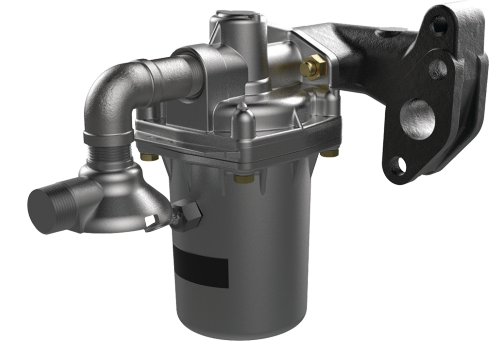

Vent Valves

- For application on long cars (>75 feet of brake pipe)
- Enhanced venting capacity results in increased emergency transmission speeds at lower brake pipe pressures
- Self-purging exhaust valve and improved corrosion-resistant design promote long-term reliability



Angle Cocks

- Teflon-coated balls provide smooth, effortless hand movement
- Self-lubricating, self-cleaning and self-adjusting rubber seals reduce leakage and can be quickly replaced



End Cocks

- Designed for use where the standard brake pipe angle cock cannot be used and where the air pressure and equipment arrangement does not exceed 150 psi



Dirt Collector Cut Out Cocks

- Enables manual cutout of brake pipe airflow to the control valve without affecting the flow to other cars
- Provides a means for removing large pieces of dirt, gravel, sand and other foreign materials before they can reach the control valve
- Provides a local sump to collect brake pipe-precipitated moisture

Braking Systems

Brake Cylinders & Reservoirs



10" Deep Drawn Brake Cylinder

Universal Brake Cylinders

- Available in 10" and 8 1/2" sizes with one part # for each cylinder size
- Incorporate three air flanges with the universal non-pressure head
- Can be oriented in four different mounting positions



Reservoirs – Combined Auxiliary & Emergency

- All Wabtec reservoirs designed according to ASME Boiler and Pressure Vessel Code, Section VIII, Division 1
- Fabricated one-piece design has two attachment lugs on auxiliary side and one lug on emergency side to ensure proper application on freight car

Braking Systems

Fittings, Hoses & Couplings



Flange Fittings

- Welded and threaded



Branch Pipe Tees

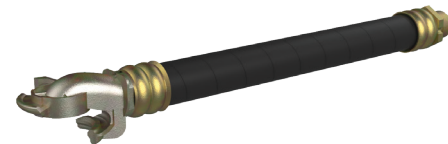

Hoses & Couplings

- Wabtec offers AAR-compliant hoses and couplings including end-of-car hoses, brake cylinder hoses, and empty/load hoses
- Withstands temperature extremes, in-service shocks and external forces

Braking Systems

Universal Hand Brakes



Vertical Wheel Type

9300, 9300-3 & 7500

- AAR Group N
- Available in long, short, or no quick release lever

4493 & 4493-3

- AAR Group O
- Available in short or long release handle

9300-3CRX & 4493-3CRX

- AAR Group Q & R
- AAR S-475, "Prolonged-Release" feature when quick released and prior to hand wheel rotation
- Continuous release feature to extend wheel life
- Available in long or short quick release lever

9300B-II, 9300C-II, 4493B-II & 4493C-II

- Equivalent to AAR Group N and O
- Double side application and quick release
- Reversing gearbox maintains wheel application direction on both sides of car
- Available in side mount, center mount, vertical and horizontal applications

Thin Lever Type



Model 9017

- AAR Group T
- Thin line lever type
- Above deck mounting on TOFC / COFC



Model 9020

- AAR Group U
- Thin line lever type
- Below deck mounting on TOFC / COFC

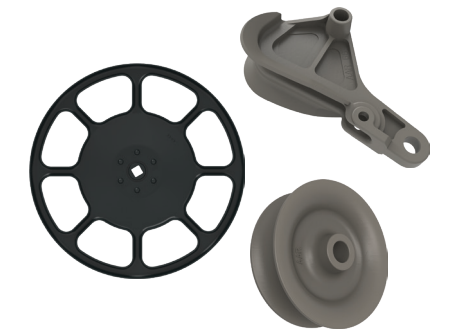

Hand Brake Parts

- Vertical & Horizontal Hand Wheels
- 4 1/2" & 8" Sheave Wheels
- Chain Joiners & Clevis / Rivet
- AAR Bell Cranks
- Shock Retarders & Chain Extensions
- Pins, Clevis & Rod Eyes

Braking Systems

Truck Mounted Brake Systems

Wabtec's TMX® & UBX® truck-mounted brake systems are made of durable, lightweight materials for a cost-effective system weighing 400-500 pounds less than conventional brake rigging.

- Simplified two-lever arrangement is easy to install and adjust and requires no mounting to the bolster or connections to the car body of any kind
- Modular design of fabricated brake beam allows application to any rail gage and unit guide combination
- Angle corrected brake heads provide even shoe wear, leading to improved economy from less frequent shoe change-outs and full utilization of friction material
- Brake cylinders, slack adjusters, and brake beams are individually replaceable and reconditionable
- Available for 70, 100, 125 ton applications and capabilities up to 45 ton axle load



TMX®

- AAR S-4005 Unconditionally Approved brake system with over 30 years of proven field history worldwide and over 250,000 units sold



TRIAX

- Utilizes standard AAR S-344 brake beams, with diagonally corrected brake heads for even shoe wear
- Utilizes same proven slack adjuster design in TMX® & UBX®



UBX®

- Fully sealed air spring actuator designed for high particulate environments.



WABCOPAC II™

- Complete brake systems & replacement parts
- Brake cylinder & lever arrangements for 70, 100 & 125 ton applications

Braking Systems

Universal Slack Adjusters

- Tension and compression used in conventional body and truck mounted brake systems
- The Universal® double acting compression slack adjuster enables automatic adjustment, with infinite increments, maintaining proper piston travel and brake shoe force
- Also offering custom slack adjusters and replacements for Triax



Model 2300-DJ

- Body mounted style
- AAR Group E



Model 2500-DJ

- Targeted on cars with direct exposure to the environment (Rain/Snow/Ice) — Tank Cars
- Interchangeable with 2300-DJ, AAR Group E
- Maintains the same universal installation as a 2300-DJ



Model C-1000-DJ

- TMX – UBX style
- AAR Group O



Model 5

- TTX truck mounted brake
- AAR Group L
- Replaces Triax model TTC-357



Model 5D

- Thrall/Davis truck mounted brake
- AAR Group M
- Replaces Triax model TTC-356

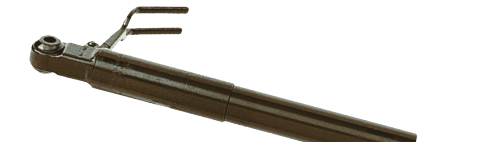

Model 85A

- WABCOPAC II style
- AAR Group P

Braking Systems

Rigging

Forged Components for Conventional Brake Rigging Arrangements

- Forged grain structure increases durability & lifetime
- Forgings eliminate welded connections (potential failure points)
- Forged levers are up to 33% lighter than those made with other manufacturing processes
- Standard and Custom sizes available to meet specific car requirements



Barber Brake Beams

- Wabtec's world-class brake beams set the industry standard for quality, durability and innovative design features
- Uni-Truss single piece design eliminates potential weld failure points and the need to shear fasteners
- Available in #18 and #24 ratings
- Available in narrow, standard and wide track gauges

Truck Lever Connections

- Hollow-forged truck lever connections manufactured from C-1040/1045 steel
- Designed to provide greater strength while eliminating all unnecessary weight
- Available in a wide range of sizes for through or under bolster applications.



Truck Brake Levers

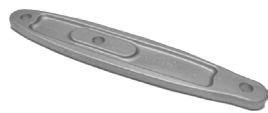

Body Brake Levers

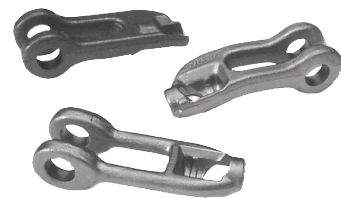

Brake Rod Jaws



Brake Rod Eyes



Brake Rod Splice



Brake Clevises



Brake Cylinder Push Rods



Brake Pins

Braking Systems

Brake Shoes

Developed to address the problem of wheel removals due to tread defects, TreadGuard® brake shoes have been proven as an effective method to increase wheel life since 1999. The benefits include:

- Extended wheel life through continuous “cleaning” of wheel tread
- Reduces high impact wheel readings by removing minor tread imperfections before they become condemnable tread defects
- AP design taper reduces the potential for wheel overheating
- Reduces wheel set inventory and out of service time
- Longer shoe life



COBRA® TreadGuard® HiCap™

- AAR M-997 Approved
- Improved resistance to brake fade on long grades
- Provides the stable friction necessary for controlled operation
- Immediate tread conditioning on first brake application (no break-in period)
- Lower wheel operating temperature offering a “cooler” operating brake
- Higher capacity rail cars, provides better performance per operative brake

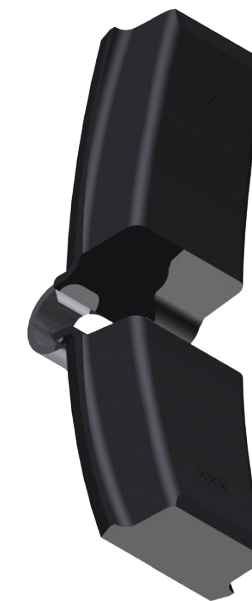

COBRA® Freight Shoe

- AAR M-926 Approved
- Optimized fit over a range of wheel sizes

Braking Systems

ECP

ECP-4200 Freight Car Brake System

Wabtec's Electronically Controlled Pneumatic (ECP) freight car brake system shortens stopping distances by 40 – 60%, improves fuel efficiency and supports increased capacity at higher average speeds.

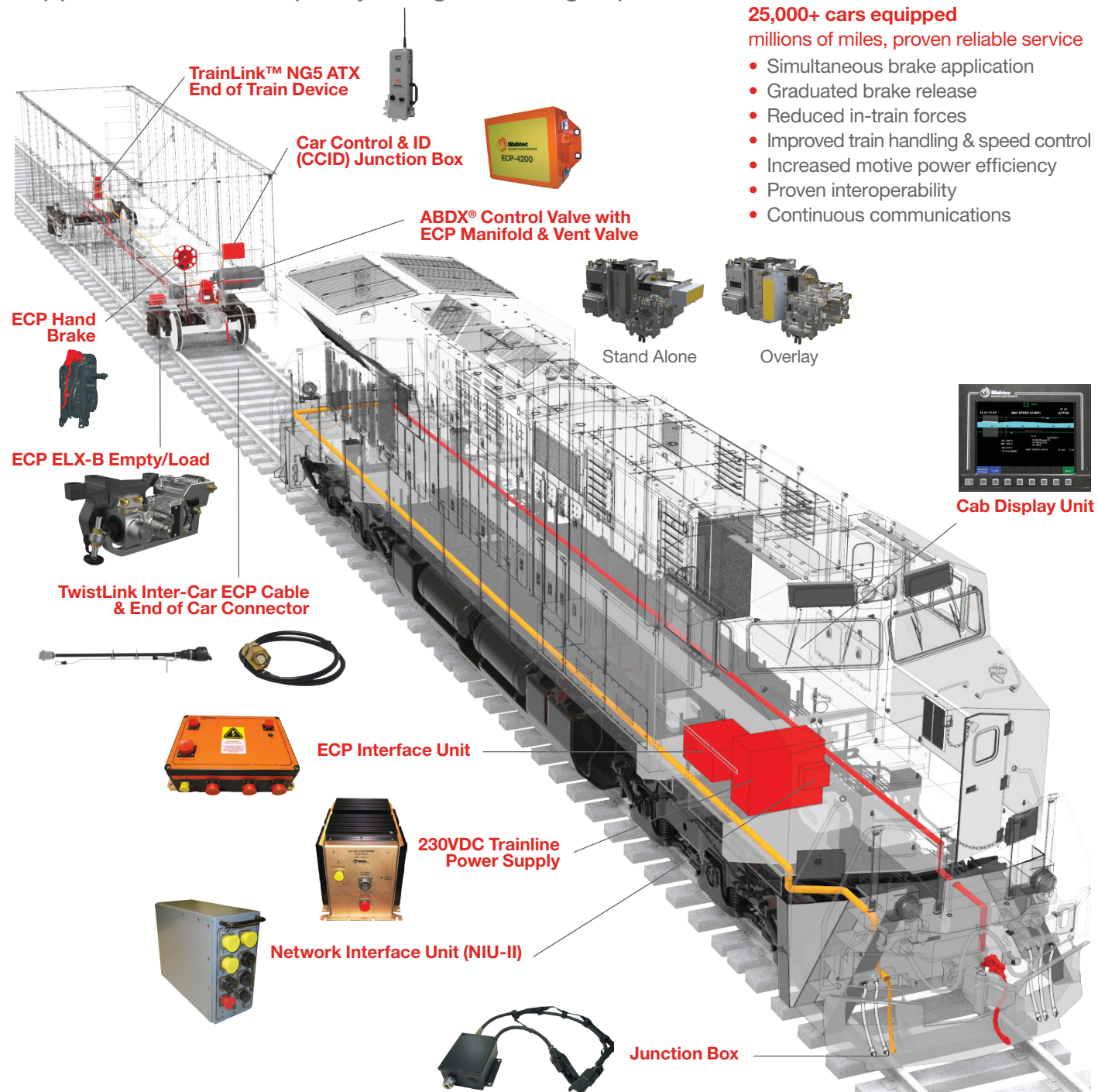

Braking Systems

Miscellaneous Components

Hangers & Supports



Air Hose Supports

- Part #AH6595

Air Hose Support Chains

- Part #CC22

Air Hose Support Cables

- Part #AH22

Bottom Rod Support

- Part #BR41

Air Hose Support Polymer

- Part #AHSE22

Rubber Components & Kits

Wabtec has multiple AAR M-1003 certified rubber molding facilities that manufacture OEM & aftermarket parts for its air brake equipment applications. Components are available individually or as complete overhaul kits.

- Packing Cups
- Diaphragms
- Check Valves
- Gaskets
- O-rings
- Strainers
- Filters
- Other Various Seals
- Complete Overhaul Kits



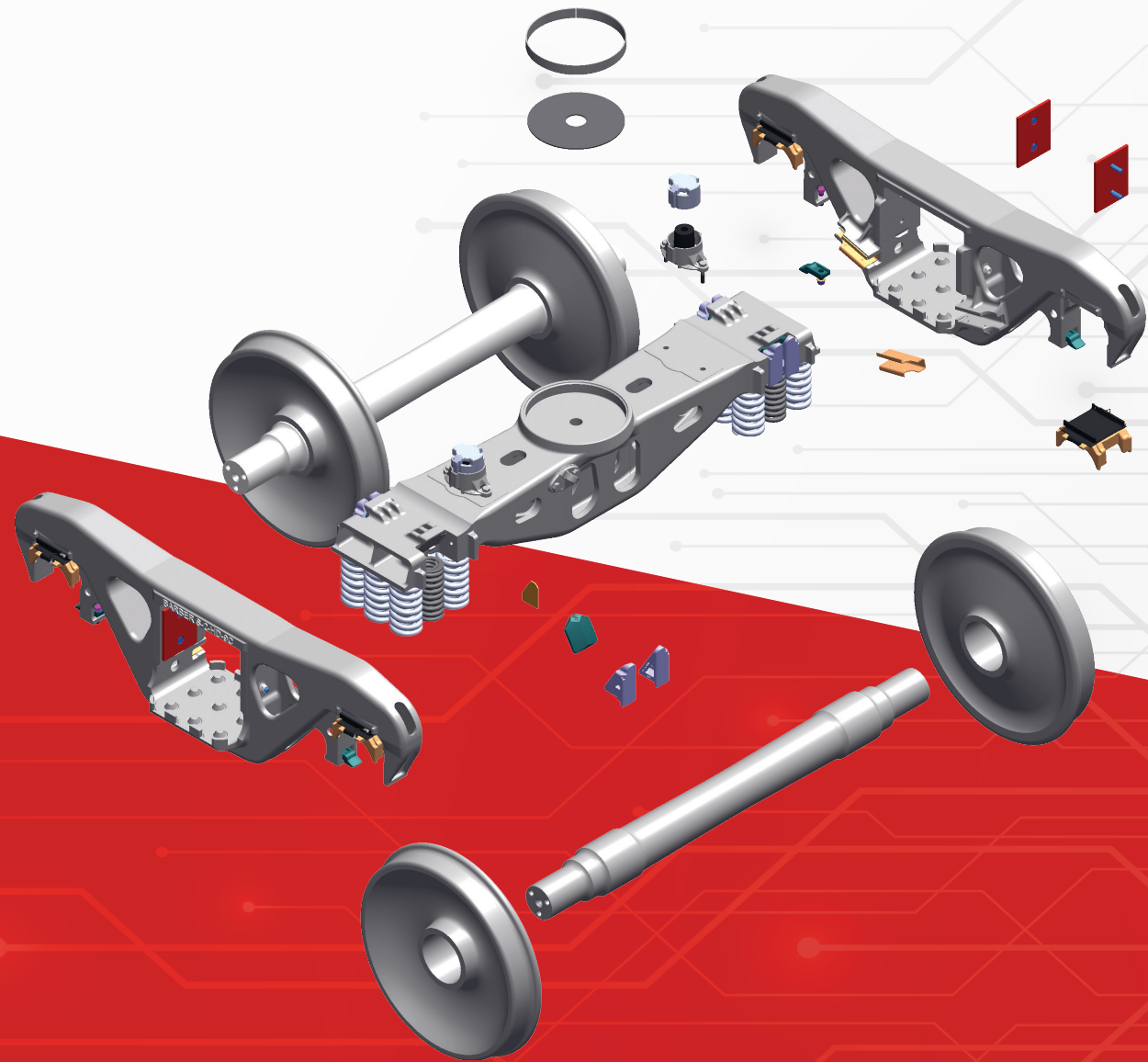

Truck Systems

- Side Frames & Bolsters Wheels & Axles Springs
- Bearing Adapters & Shear Pads Friction Wedges Side Bearings
- Wear Prevention Center Plates Miscellaneous Components

Truck Systems

Barber® Side Frames & Bolsters

Wabtec is a leading provider of freight car stabilization systems and components.

Features / Benefits

- Designed and tested by Wabtec to meet or exceed AAR standards
- Manufactured in AAR M-210 and M-1003 Approved Foundries
- 100% Magnetic Particle inspected for cracks (no AAR Requirement)
- 100% Gaging (AAR requires sampling only)
- Wabtec quality inspectors at each foundry
- 25 year successful service history

M-976 Approved Trucks

- S-2-HD 9 Coil
- S-2-HD9 Coil Lightweight (6,542 lbs)
- S-2-HD 6 Coil – Low Profile
- S-2-E 917 Integral Wedge
- S-2-E 945 Split Wedge (for certain car types)

Other Gross Rail Loads – Intermodal and Other Service

- 125 T S-2-HD
- 110 T S-2-C
- 70 T S-2-C

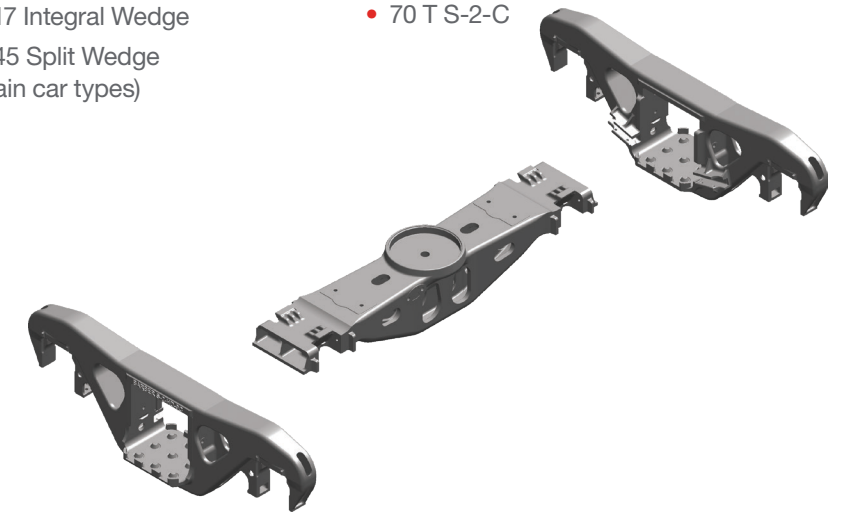

Truck Systems

Wheels & Axles

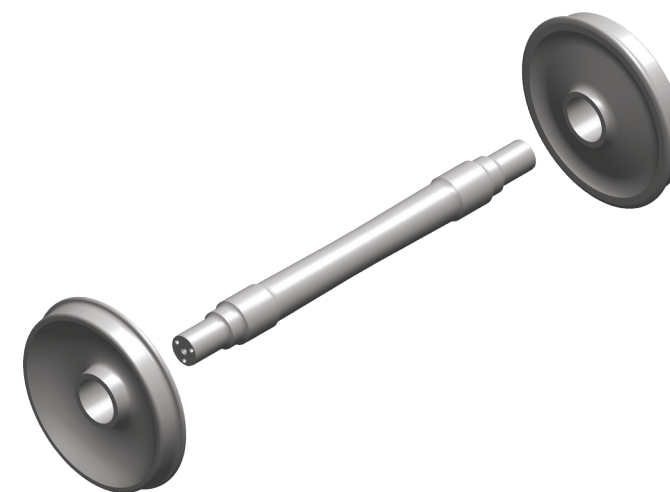

Wheels

- Manufactured to AAR M-107/208 standards
- Forged Wheel

Axles

- Manufactured to AAR M-101 standards
- Available in rough or finish machined

Truck Systems

Springs

- AAR standard load and side springs for all truck suspension systems
- Custom hot-wound springs available in 1/2 inch to 4 inch bar diameters

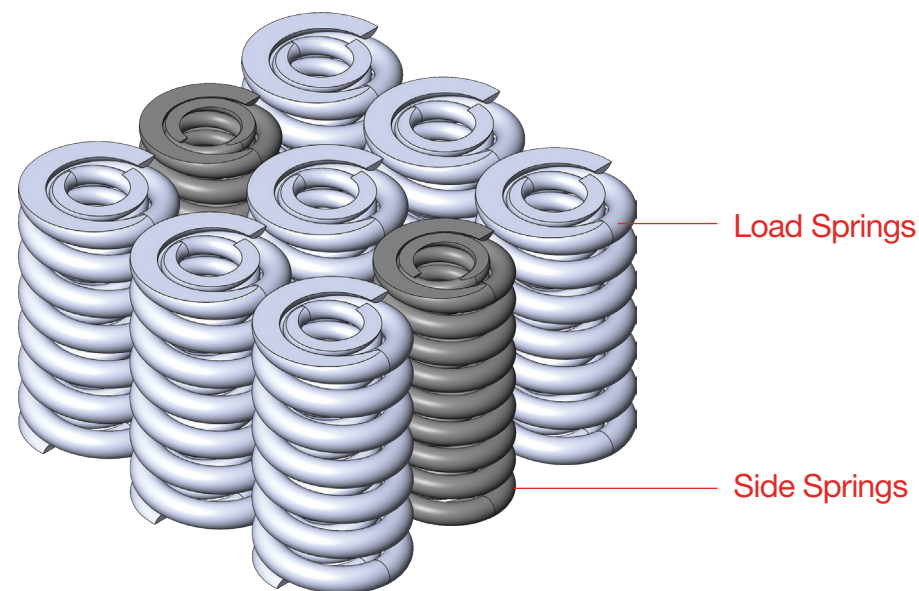

Truck Systems

Bearing Adapters & Shear Pads

The Barber S2-86® Radial Adapter primary suspension system provides passive steering performance. A single layer of rubber bonded between two steel plates and situated above the bearing adapter allows for radial alignment of the wheelsets during curving, reducing rolling resistance and improving rail and wheel life.



Barber S2-86® Radial Bearing Adapter

- M-976 track tested and approved on a variety of trucks
- Fits standard AAR pedestal - no special side frames required
- Durable vulcanized rubber to steel bond
- Rubber maintains properties over wider temperature range than other polymers
- Resilient rubber surface provides better load distribution across pedestal roof discontinuities
- Rejection lugs prevent misapplication

Truck Systems

Friction Wedges

Wabtec pioneered the design of variably damped Barber® suspension systems. Our friction wedges are designed to provide optimum damping and wear performance and are interchangeable in all Barber® truck designs.

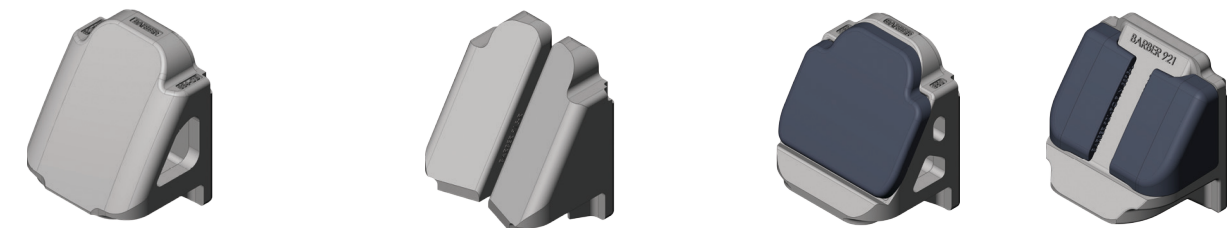

Barber® Integral Iron Wedges

- Commonly used on all Barber®-designed trucks
- Solid-piece cast iron wedge

Barber® Iron Split Wedges

- Split wedges increase truck warp resistance (squaring) versus traditional single piece wedges, providing improved high speed stability and curving performance without compromising vertical damping

Barber® LifeGuard Wedge Barber® TwinGuard Wedge

- Polymer-faced wedge significantly reduces bolster pocket wear on both the slope surface and side walls
- Highest deformation temperature of any polymer wedge, 350°

Steel Wedges for ASF Type Trucks

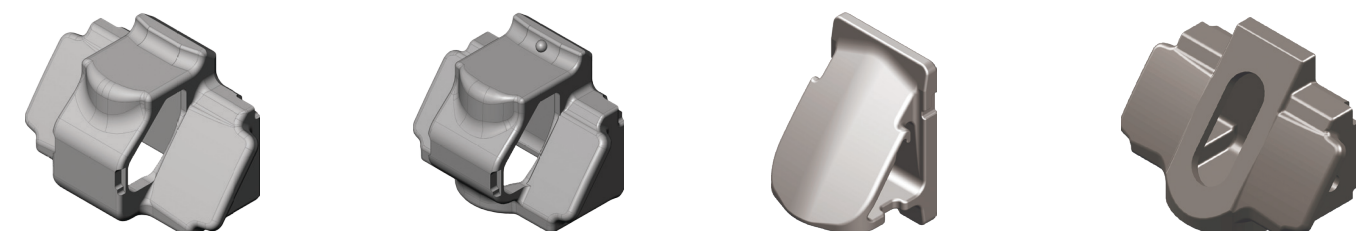

17803

17815

17823

17882

| Amsted Truck System | Damping | Wedge # |
|-----------------------------|----------|---------|
| Ride Control® | Constant | 17803 |
| Super Service Ride Control® | Constant | 17815 |
| Ride Master | Variable | 17823 |
| Super Service Ride Master | Variable | 17882 |
| Motion Control® | Variable | 17882 |

Truck Systems

Side Bearings

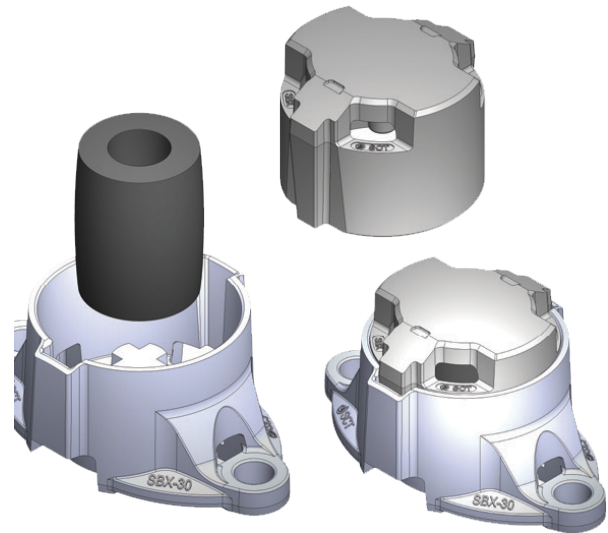

SBX Type Constant Contact Side Bearings

- AAR M-948-2006 premium approved
- 5/8" long travel
- Patented vented top cap for lower operating temperatures
- Top cap metallurgy provides consistent friction as well as superior wear characteristics
- Elastomeric spring designed for consistent performance and vertical damping over an extended temperature range
- Tightly machined cap/cage interface for stability and long life

| Model # | Preload Weight |
|---------|----------------|
| SBX-30 | 3,000 lbs. |
| SBX-45 | 4,500 lbs. |
| SBX-60 | 6,000 lbs. |
| SBX-80 | 8,000 lbs. |

Replacement Blocks for Stucki Constant Contact Side Bearings

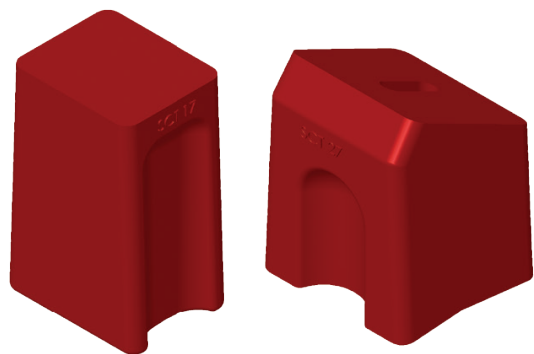

| Model # | Preload Weight | Block |
|-------------------------------------|----------------|------------|
| Resilient | | |
| 690-RL | 3,600 lbs. | SCT-17 (3) |
| 656-CR | 6,000 lbs. | SCT-11 (2) |
| 688-BR | 6,000 lbs. | SCT-9 (3) |
| Metal-Capped | | |
| 675-RL | 3,000 lbs. | SCT-24 (2) |
| 685-RM | 4,500 lbs. | SCT-34 (2) |
| 656-CRH | 5,400 lbs. | SCT-27 (2) |
| Roller Assist – Metal Capped | | |
| ISB-8 | 3,000 lbs. | SCT-24 (2) |
| ISB-10 | 4,500 lbs. | SCT-34 (2) |
| ISB-12 | 5,400 lbs. | SCT-27 (2) |
| Retrofit Long Travel Upgrade | | |
| RetroXT 5400C | 5,400 lbs. | SCT-56 (2) |
| RetroXT LP Drop In | 4,500 lbs. | SCT-57 (2) |

Truck Systems

Wear Prevention

Center Plate Wear Liners



Center Plate Vertical Rings

- 14" or 16" diameter
- Stainless steel



Manganese Steel Horizontal Liners

- 14" or 16" diameter
- Available in manganese or ASTM-514 steel

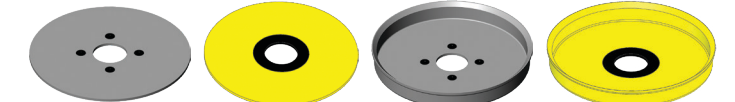

Polymer Center Plate Liners

- Horizontal or one piece drop-in types available
- Various cold flow and wear resistant polymer grades
- Durable, patented electrical ground connections
- Available in 2" or 2 1/4" depth

Bolster Pocket and Side Frame Wear Plates & Inserts



Bolster Pocket Slope Wall Wear Plates

- For use with single piece wedges



Bolster Pocket Side Wall Wear Plates

- For reconditioned or new bolsters



Bolster Pocket Inserts

- For use with split wedges

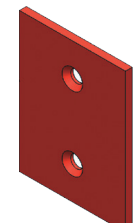

Side Frame Column Wear Plates

- Multiple fastener hole options available

Brake Beam Guides & Liners

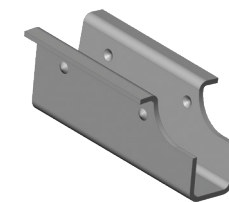

High Carbon Steel

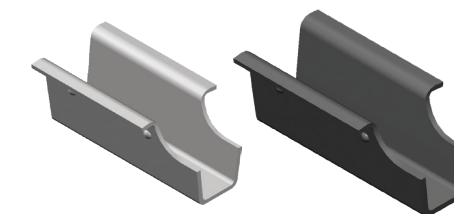

Non-Metallic

- Wear resistant polymer
- Available in standard and heavy duty models

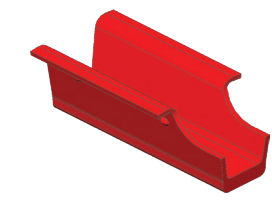

Brake Beam Centering Unit Guide Liners

- Helps prevent overhanging brake shoes

Truck Systems

Wear Prevention

Brake Rod Wear Protectors

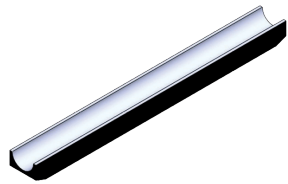

Brake Rod Wear Protectors

- Available in 12, 18 & 24 sizes

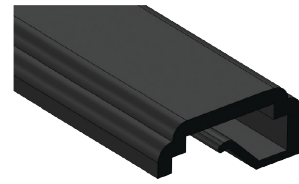

Brake Hanger Wear Protectors

- Available in various lengths & beveled ends

Coupler Carrier Wear Protectors

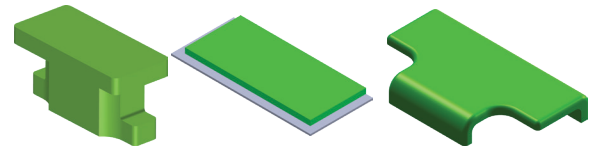

Coupler Carrier Wear Protectors

- Available in weld-on & drop-in models
- Offered in a variety of sizes & thicknesses

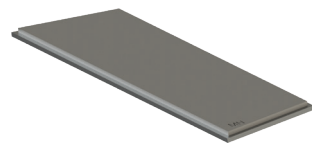

Bi-Metal Wear Plates

- Available in a wide array of dimensions



Manganese Steel Wear Plates

- Available in 9/32", 7/16" & 15/32" thicknesses

Pedestal Roof Liners

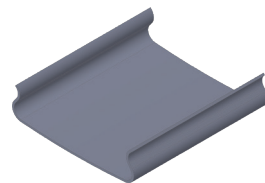

TransDyne Liners

- Industry standard

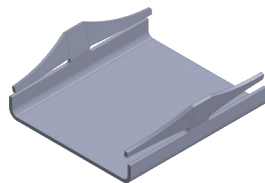

Dyna-Clip

- Improved durability

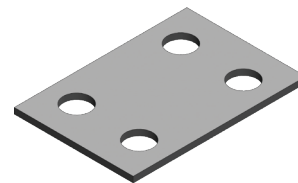

Roof Liners

- Available for 70, 110 & 125 ton trucks

Truck Systems

Center Plates

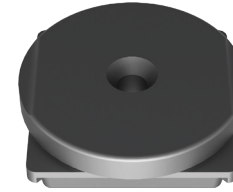

Drop In Low Profile Center Plates

- CP16 (Forged)
- F2246 (Cast)



Separable Center Plates

- Available in 14" or 16" sizes



Center Pins

Truck Systems

Miscellaneous Components

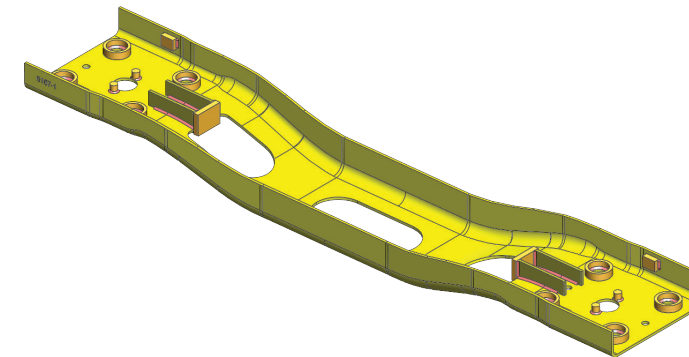

Bolster Transoms

- For use in Swing Motion® trucks
- Available for 70 ton standard & low conveyance trucks



Bolster Replacement Gibbs

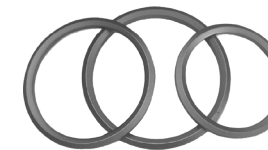

Bolster Replacement Rings



Brake Shoe Keys

- Available stamped or forged



Side Frame Keys

End of Car Systems

Coupler System Draft Gears Cushioning Units
 SAC-1™ Spherical Articulated Connector Miscellaneous Components

End of Car Systems Coupler System

- AAR approved couplers, yokes, and E and F-M216 knuckles
- Castings are 100% hardness tested, gaged, MPI inspected, fit and operated to ensure quality
- Available as individual coupler bodies or completely assembled fits

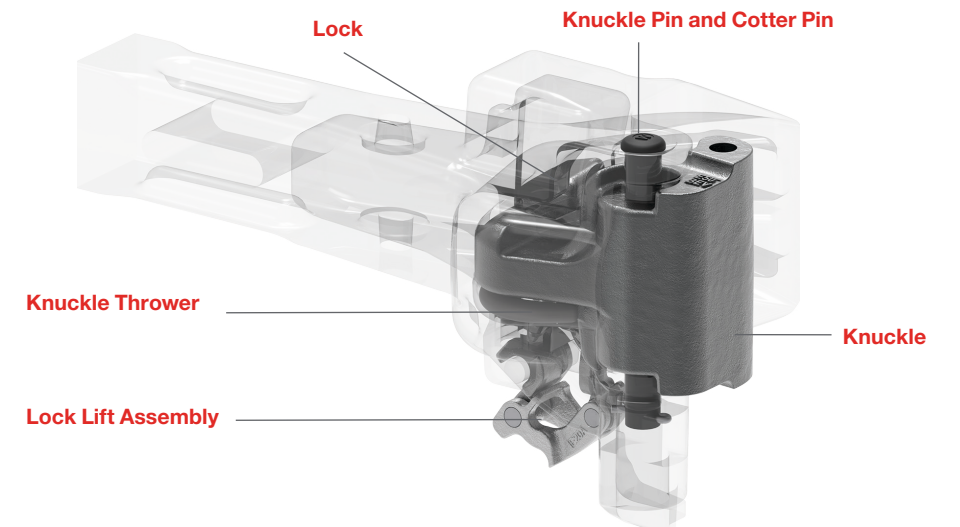
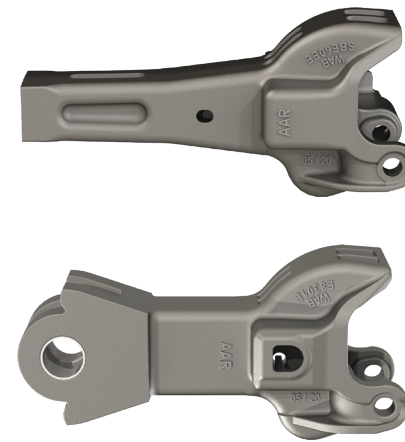

| Type | Model # | Shank Length | Shelf Configuration |
|------------|----------|--------------|---------------------|
| E | E60EE | 21.5" | None |
| | SBE60EE | 21.5" | Bottom |
| | SBE67DE | 25" | Bottom |
| | SE60EE | 21.5" | Top & Bottom |
| E/F | SBE68DE | 31" | Bottom |
| | SBE69CE | 48" | Bottom |
| | E69CE | 48" | None |
| | EF511CE | 31" | Bottom |
| F | F70DE | 17.25" | Bottom |
| | SF70DE | 17.25" | Top & Bottom |
| Rotary | FR210E | 17.125" | Bottom |
| Locomotive | E8301E | 16.5" | None |
| | SBE8301E | 16.5" | Bottom |
| | E4881AE | 16.5" | None |
| | F8301E | 16.5" | Bottom |

End of Car Systems

Coupler System

Coupler Operating Parts



Knuckles

- M216 E and F knuckles
- Over 1 million in service
- Solid face locomotive knuckles available



Knuckle Throwers



Lock Lifters



Locks

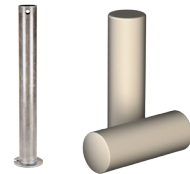

Knuckle & Coupler Connection Pins

Yokes



SY40AE – Type E



Y45AE – Type F



RY210E – Rotary

Followers

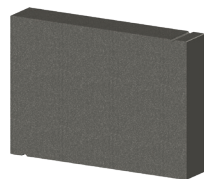

Y44A – Type E

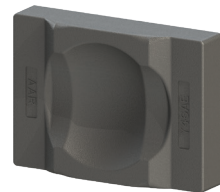

Y46AE – Type F

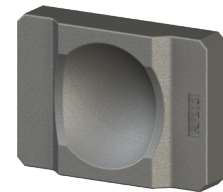

RF210 – Rotary

| Part Name | AAR E & E/F | AAR F | Rotary | Locomotive E | Locomotive F |
|-----------|-------------|---------|--------|--------------|--------------|
| Knuckles | E50BEV | F51AEV | F51AEV | SE50 | SF51 |
| Locks | E42BE | F41AE | F400AE | E40AE | F45AE |
| Lifters | E24B | F7, F8A | RLL | E6A | E6A |
| Throwers | E30A | F31A | F31A | E30A | F31A |
| Yokes | SY40AE | Y45AE | RY210E | – | – |
| Followers | Y44A | Y46AE | RF210 | – | – |

End of Car Systems

Draft Gears

- Wabtec designs and manufactures Mark series draft gears
- Self-contained and shipped pre-compressed for easy application to cars
- Remaining gear life can be measured in the car without removal
- Reconditionable for extended service life



Mark 50

- All steel, friction, high performance in any operating environment
- Replaceable hardened friction plates for long service life
- First draft gear to receive AAR unconditional approval to M901E and largest install base in the world
- All car types, up to 286k GRL
- AAR M901E, 24-5/8" Pocket with 3-1/4" Travel
- AAR Rated Capacity = 38,940 ft-lbs.
- AAR Rule 21 Group J
- Weight = 386 lbs.



Mark 70E

- All steel, friction, high performance in any operating environment
- Lightest all steel friction draft gear approved to M901E
- All car types, up to 286k GRL
- AAR M901E, 24-5/8" Pocket with 3-1/4" Travel
- AAR Rated Capacity = 42,193 ft-lbs.
- AAR Rule 21 Group J
- Weight = 312 lbs.



Mark 90AT

- Steel clutch/polymer spring – advanced technology
- Lightest, high capacity draft gear
- All car types, up to 286k GRL
- AAR M901E, 24-5/8" Pocket with 3-1/4" Travel
- AAR Rated Capacity = 46,265 ft-lbs.
- AAR Rule 21 Group J
- Weight = 265 lbs.



Mark R-500

- All steel, friction, steel/rubber main spring
- Replaceable hardened friction plates for long service life
- All car types, up to 286k GRL
- AAR M901E, 24-5/8" Pocket with 3-1/4" Travel
- AAR Rated Capacity = 44,000 ft-lbs.
- AAR Rule 21 Group J
- Weight = 384 lbs.



Mark 558

- All steel, friction, high performance in any operating environment
- Replaceable hardened friction plates for long service life
- First all friction draft gear to receive AAR unconditional approval to M901G (multi-platform/intermodal units)
- AAR M901G, 24-5/8" Pocket with 3-1/4" Travel
- AAR Rated Velocity = 5.58mph
- AAR Rule 21 Group K
- Weight = 363 lbs.



Mark 390

- Locomotive draft gear for E/F/H couplers
- Alignment control feature
- 13-3/4" Pocket with 1-1/2" Travel
- Capacity = 35,000 ft-lbs. @ 1 mil lbs.

End of Car Systems

Cushioning Units

Wabtec's FreightMaster™ hydraulic cushioning units are designed and engineered to reduce end-of-train forces. Our broad, AAR-approved product portfolio serves a range of different car type needs. Protect your investment from start to stop with Wabtec's end-of-car cushioning units.

- Gas pre-charged hydraulic cushioning system designed for superior impact absorption
- For installation in new cars or as a replacement to any existing cushioning unit
- Wabtec converts or upgrades older spring return and non-preload units to current AAR standards

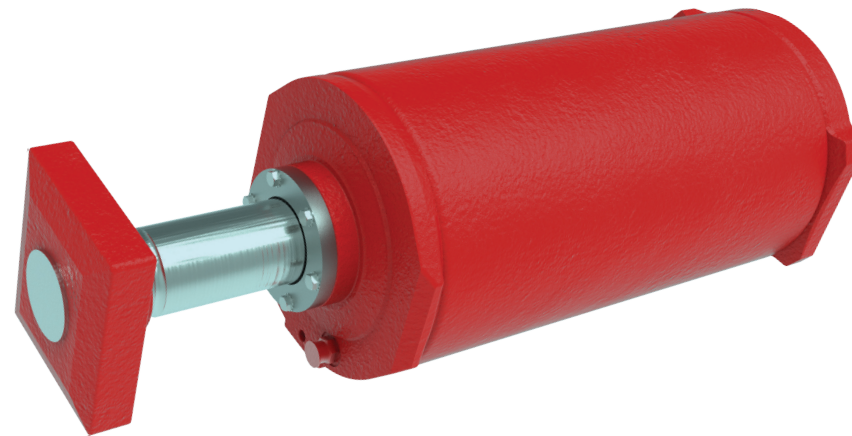

EOCC Yokes



E Type Yokes



F Type Yokes

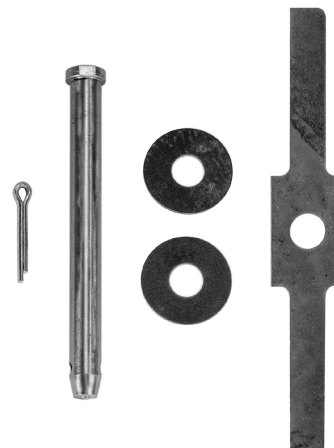

Pin Retainer Kits

- Y-47 Vertical Pin Retainer Bolt Replacement Kits for EOCC Yokes per AAR M119 and Rule 17

End of Car Systems

SAC-1™ Spherical Articulated Connector

Wabtec offers a semi-permanent connection coupling system featuring a low maintenance, self-lubricating design.

Designed to maintain a slack-free connection, the SAC-1™ eliminates the need to stop cars for lubrications and readjustments of side bearing heights. Built for today's competitive transportation market, it offers substantial weight savings, improved car handling and reduced operating costs.

- Patented self-lubricating liner and spherical ball assembly (maintenance free)
- Positive slack-free connection
- Minimizes side bearing height adjustments
- Minimal-to-no center plate wear as compared to the competition
- 14" and 16" center plates are available for use on 70, 100, and 125 ton applications
- Vertical travel of +/- 11° eliminates uncoupling and re-coupling during wheel change outs and maintenance
- Horizontal travel of +/- 22°
- +/- 13° Roll
- Designed and tested to 1.25 million lbs. buff force and 630,000 lbs. of draft force



End of Car Systems

Miscellaneous Components



Draft Keys, Washers, Retainers & Keepers



Front & Rear Draft Lugs



E & F Type Strikers



Draft Key Wear Protectors

- Non-metallic, wear resistant material
- For new cars or convert to snap on design for existing cars
- No draft key removal required



Uncoupling Levers & Brackets



Hydrojack II® Draft Gear Removal Device

- Compatible with all coupler systems

Specialty Components

Hatch Cover Systems

Outlet Gate Systems

Car Body Parts & Fabrications

Autorack Solutions

Other Freight Car Parts

Specialty Components

Hatch Cover Systems

With over 30 years experience, Wabtec is the acknowledged industry leader. We know hatch covers.

Whether your cars were built decades ago or are brand new, we have the expertise you can trust for your cars and service. Troughs, rounds, fiberglass, steel, aluminum, food grade, corrosion resistant, dual opening or batten free are just some of the options available to protect your commodity.

- Replacement covers for entire N.A. hopper car fleet
- Standard and custom solutions for specific car requirements
- Patented Quantum design eliminates need for batten bars
- Industry leading warranties

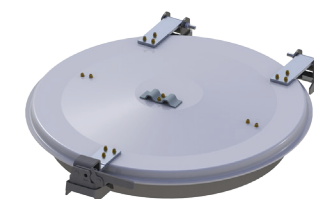
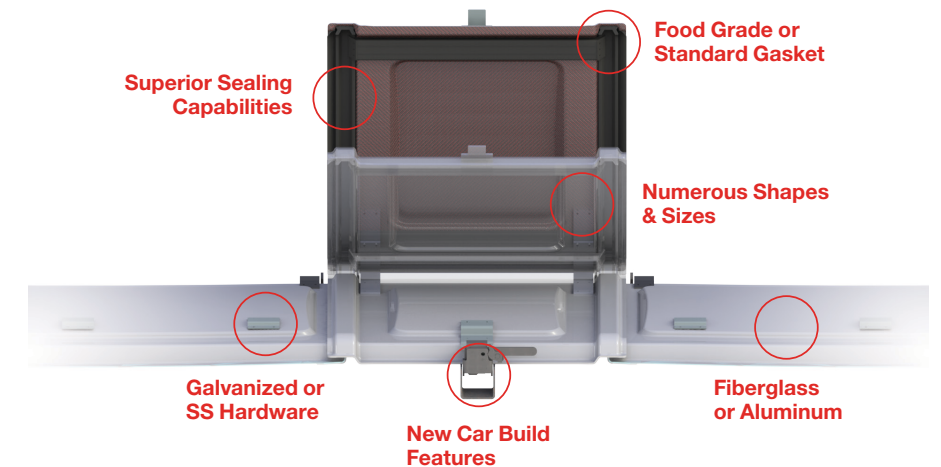

30" Round Covers

- Aluminum, Fiberglass Composite, Steel or Stainless Steel
- Standard or Food Grade gaskets
- Single or dual-hinge

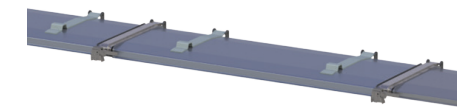

Conventional Covers

- Aluminum or Fiberglass Composite
- Standard or Food Grade gaskets
- Conventional batten bar system

Accessories

- Adapter Ports
- AEROvent / CarVent
- Batten Bars
- Coaming Rings
- Hatch Cover Gaskets
- Hatch Cover Hardware

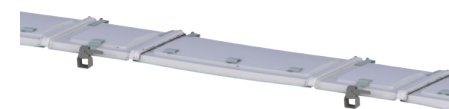

Quantum Plus Covers

- Aluminum or Fiberglass Composite
- "Triple Seal" gasket system available in Standard or Food Grade
- Lightweight design

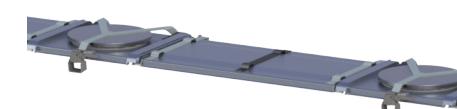

Quantum Plus Port Covers

- Aluminum or Fiberglass Composite
- Superior gasket system compared to conventional covers
- Load through port hatch covers to reduce dusting

Specialty Components

Outlet Gate Systems

Wabtec's AEROgates are highly durable, user-friendly outlet gates that will protect your commodity for the long haul.

These innovative designs are based on years of research attacking and eliminating the most common gate issues, including pinion skipping, door plate ejection, and door plate sealing. Steel, stainless steel, powder coat, and various sizes are just a few of the infinite AEROgate options available.

- UHMW seals
- No pinion skipping
- Low operating torque
- Industry leading warranties

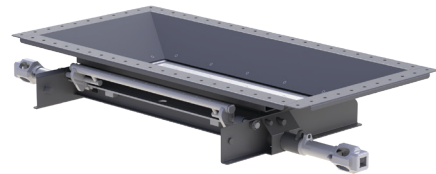
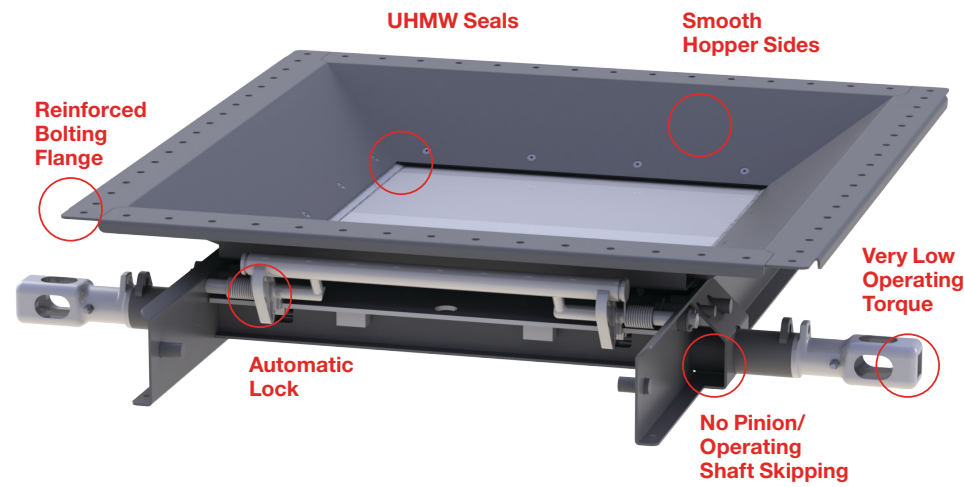

Standard

- Cement, Fly Ash, Sand

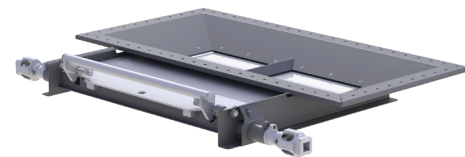

Universal

- Cement, Frac Sand

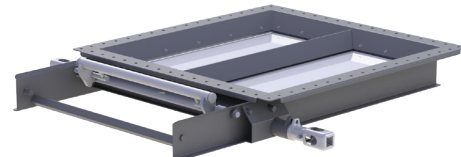

Low Profile

- Agricultural, Soybean Meal

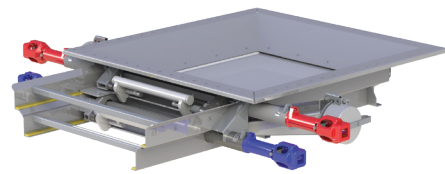

Gravity Pneumatic

- Barley, Malt, Rice, Sugar

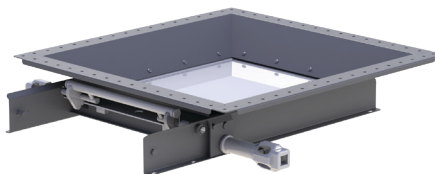

S-Series

- Agricultural, Soybean Meal

| | 13 x 42 | 24 x 30 | 30 x 30 | 42 x 42 | 24 x 48 | 43 x 54 |
|-------------------|----------|-----------|----------------|---------|---------|---------|
| Standard | A74 | | A73 | A83 | A71 | A127 |
| Universal | A161 | | | | | |
| Low Profile | A87 | | A133 | | | |
| Replacement | W20 | W10 & W15 | | | | |
| Gravity Pneumatic | A113 PVC | | A83 PVC & AV27 | | | |
| S-Series | | | A139 | | | |

Specialty Components

Car Body Parts & Fabrications

Aluminum Coal Car Components

Wabtec has developed a large and continually growing product line of OEM-quality aluminum extrusions and fabricated sheet products for coal car repair and maintenance purposes.

- Corner Caps
- Side Posts & End Posts
- Top Chords & End Chords
- Side Sills
- Interior Bracing & Connections
- Tubs & Related Components
- Side Sheet Splices
- Door Pans & Spreader Beams
- Yoke Pin Supports
- Custom Fabricated Sheet Products

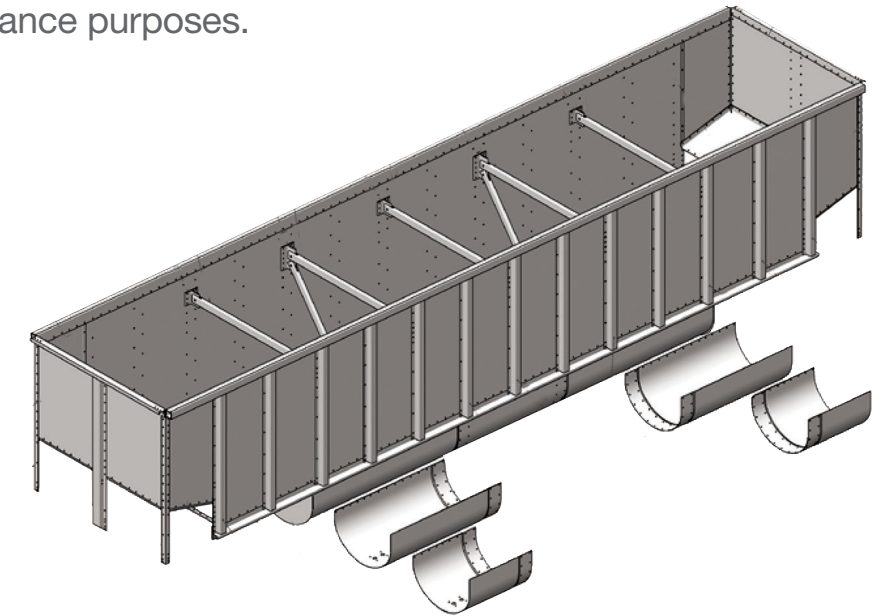

Gondola & Open-Top Hopper Cars



Corner Caps



Vibrator Brackets

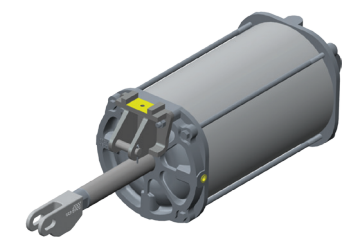

Pneumatic Gate Actuating Cylinders



Gate Mechanisms (Cam Lock)



Gate Mechanisms (Adjustable Lock)

Specialty Components

Autorack Solutions

Wabtec offers a variety of autorack rail car products designed to protect vehicles while in transit.

Chock Systems

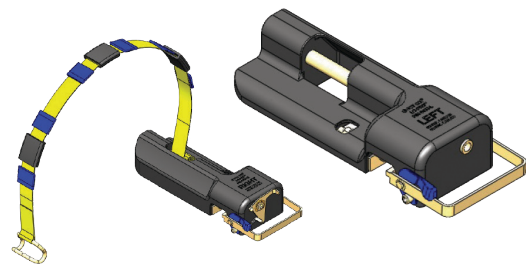

Lo-Pro™ Polymer Chocks

- Designed for application on conventional tri-levels and other specialty bi and tri level autoracks
- Low profile design addresses reduced underbody clearances of existing and future vehicle designs
- Anchor chock design requires adjustment of only one chock, simplifying the loading process
- Fold over captivation strap reduces ratchet counts required during tie down for faster installation
- Easy foot lever release
- Fully reconditionable

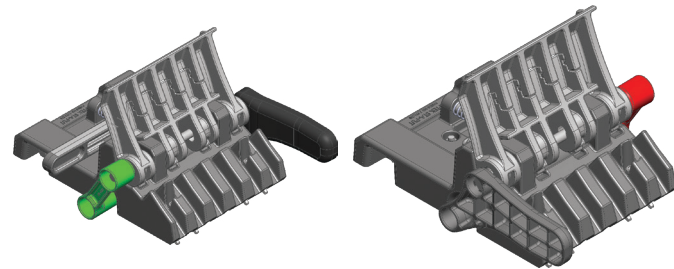

Sta-Put™ Bi-Level Chocks

- Prevents horizontal movement of vehicles during transit
- Low profile design addresses reduced underbody clearances of existing and future vehicle designs
- Three adjustable height settings
- Supports a broad range of vehicle weights and tire sizes
- Ergonomic design is easy to apply
- Seamless integration with current bi-level chock system
- Strap available to accommodate tri-level autoracks
- Fully reconditionable; also field repairable

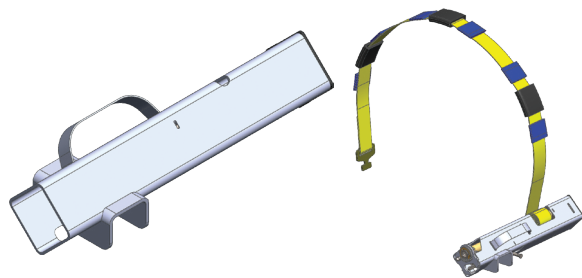

Hybrid Lo-Pro Steel Chocks

- Lowest profile tri-level wheel chock
- Strongest construction of any new low profile securement (steel construction)
- Design addresses reduced underbody clearances of existing and future vehicle designs
- Fold over captivation strap reduces ratchet counts required during tie down for faster installation
- Easy foot lever release
- Fully reconditionable

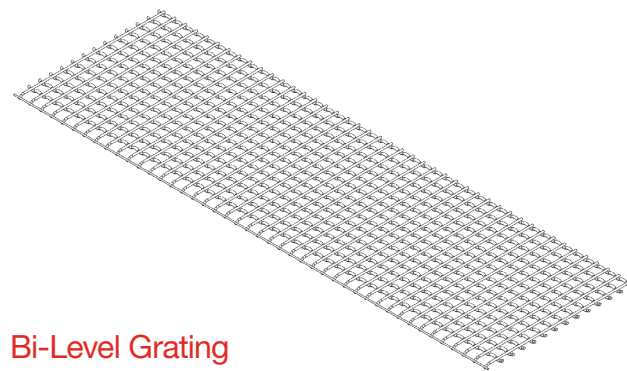

Bi-Level Grating

- Used in bi-level and specialty tri-level autoracks
- Various lengths available
- Hinges and fasteners also available

In addition to reconditioning Wabtec chock designs, we also recondition GLC chocks.

Specialty Components

Autorack Solutions

EdgeGard® II Door Protection System: Protects vehicle door profiles from damage.

- Universal applications designed for bi- and tri-level autoracks regardless of car manufacturer
- Offering the widest area of post protection regardless of load configuration
- Made from an engineering grade polymer that withstands the elements
- Offering quick and simple installation with push-in fasteners
- Side Screen profiles require no tools for installation
- Meets or exceeds AAR requirements
- Zero moisture absorption
- Maximum amount of UV inhibitors added to material
- Fully recyclable

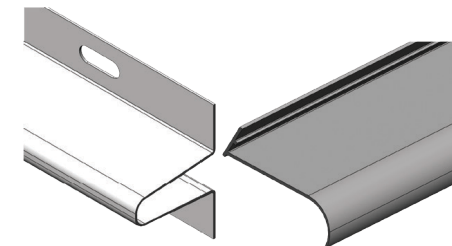

Side Screen Profiles

- 100" or 64" Side Screen Profile or "C" Deck Roof Profile

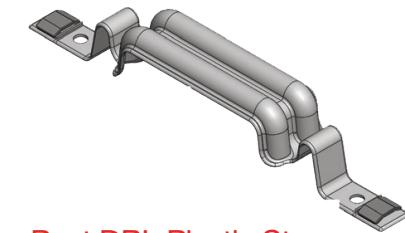

Post DBL Plastic Straps

- Available in 8", 16", 23", 30", 37" and 45"

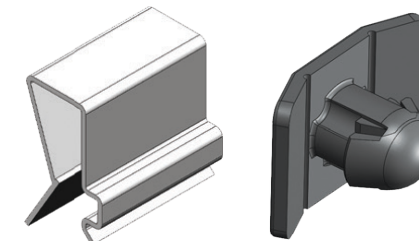

Roof Clips & Push-in Fasteners

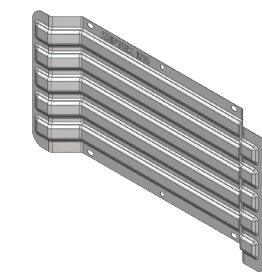

EdgeGard® AVC & Uni-Level

Miscellaneous Components

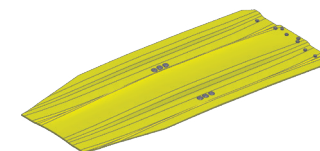

Bridge Plates

- Available in 53" & 56"
- Field repairable hinge

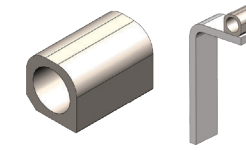

Bridge Plate Supports



Multi-Level (Tri-Level) Deck Spring

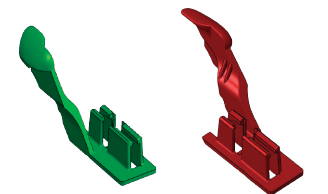

Grate Lock Chock Locking Lever Retainer/Tab

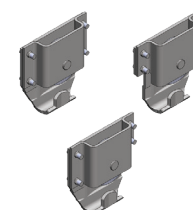

Multi-Level Door Roller Assemblies

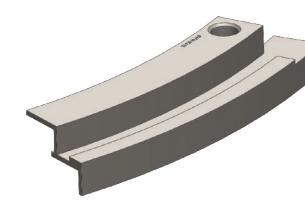

Door Track Splices

- Avail. for all door track types
- Saves time & cost of repair



No-Lube Door Guides

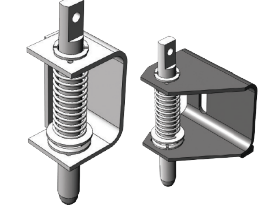

Standard & No-Lube Door Locks

Specialty Components

Other Freight Car Parts

Tank Car Components

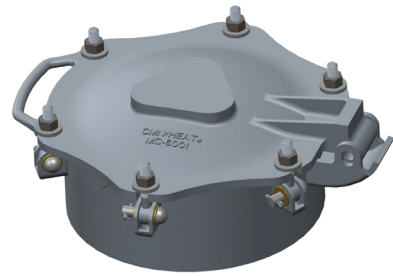

Manway Covers

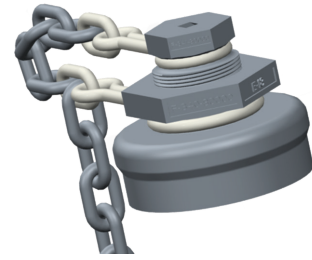

Bottom Outlet Cap & Plug / Adapters

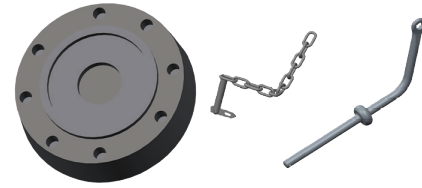

Outlet Saddles, Seal Pins, Lock Caps & Skid Plates

CoilGard®

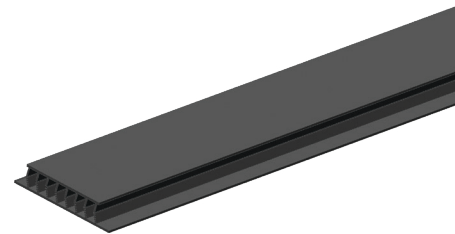
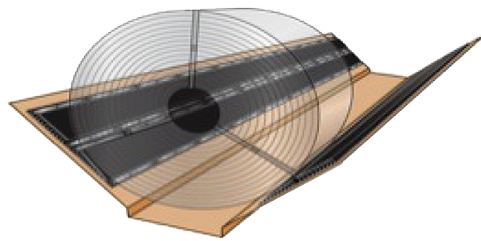

CoilGard® Coil Shift Preventers

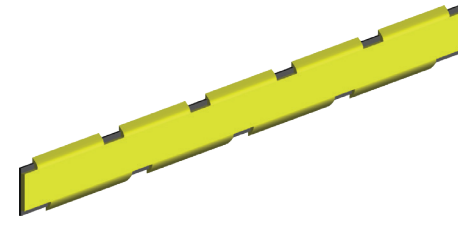

CoilGard® Crossbar Liners

Miscellaneous

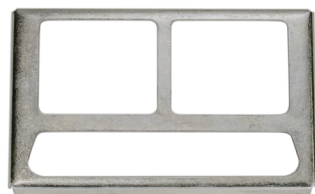

Route Card Holder



Placard Card Holder

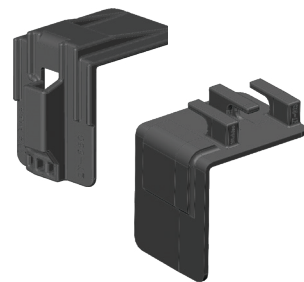

Lumber Corner Protectors

- Cable assemblies also available



Riv-Bolts & Collars

- 1/4" – 7/8" diameters
- .188" – 5" grip range
- Interchangeable with Huck® bolts
- Application equipment also available

Global Field Services & Repair

Component Reconditioning Education Technical Support

Wabtec's Global Field Services & Repair teams are focused on meeting the ever-changing needs of the rail industry.

We take pride in our ability to offer top-quality maintenance solutions that quickly restore performance.

With over 130-years-experience, we offer the finest in reconditioning and upgrade service, including pneumatic repair, electro-mechanical repair, as well as inventory management, and a variety of software solutions that facilitates the real-time capture and analysis of data.



Global Field Services & Repair

Component Reconditioning

Wabtec's reputation for developing advanced equipment for freight cars is unsurpassed. No other supplier has more experience or has made more distinguished contributions in

this sensitive, complex, and strategic area. Reconditioning services are performed at the Wabtec service locations listed below:

| | Chicago, IL | Columbia, SC | Kansas City, MO | Chillicothe, OH | Montreal, Canada | San Luis Potosi, Mexico | Contagem, Brazil | Kempton Park, South Africa | Maputo, Mozambique | Rydalmere, Australia |
|---|-------------|--------------|-----------------|-----------------|------------------|-------------------------|------------------|----------------------------|--------------------|----------------------|
| Control Valves | | | | | | | | | | |
| ABD, ABDW, ABDX & DB | | • | • | | • | • | • | • | • | • |
| Upgrades – Stabilization, Leakage & Vibration Protection | | • | • | | • | • | • | • | | • |
| AB Related Equipment | | | | | | | | | | |
| Angle Cocks, End Cocks, Dirt Collectors, Retaining Valves | | • | • | | • | • | • | | • | • |
| Vent Valves (#8, VX, KM2) | | • | • | | • | • | • | | • | • |
| Empty and Load Valves (P-1, S-1, SC-1U, ELX, L-1) | | • | • | | • | • | • | | • | • |
| Brake Cylinders, Piston Assemblies | | • | • | | • | • | • | | • | • |
| Freight Car Air Test Devices | | • | • | | • | • | • | | | • |
| Other Components | | | | | | | | | | |
| Draft Gear (Mark series, Crown and TF-880) | • | | | | | | | | | |
| Truck Mounted Brakes (WabcoPAC, TMX & UBX) | • | • | | | | | | | | • |
| Slack Adjusters | • | • | | | • | • | • | • | • | • |
| End of Car Cushioning (FMI, KRE, AHO) | | | • | | | | | | | |
| Wheel chocks | | | | • | | • | | | | |

Global Field Services & Repair

Education and Technical Support

Wabtec offers comprehensive training seminars and material geared toward educating rail personnel on the operation and maintenance of rail equipment.

Annual training classes are held at our Wilmerding, Pennsylvania facility in the spring and fall. In addition to freight car classes, locomotive offerings are also available.

Freight Air Brake Training Class

This training class focuses on the fundamentals of freight train air brakes, per AAR S-486, to include the history of freight car air brakes to current innovative designs. The course covers air brake component identification and function and culminates in a demonstration on the 250-car test rack. The course is highly recommended for design engineers, air brake superintendents/supervisors and anyone involved in training functions.

Books and Materials

Wabtec offers a wide variety of material geared toward educating rail personnel on the operation and maintenance of rail air brake equipment.



On-Site Training / Field Services

Our on-site training classes are presented by experienced Federal Railroad Administration (FRA) Designated Instructors. In addition to Operational Training, Maintenance Training, Calibration, Tester Upgrades & Service, our courses include:

Single Car Air Brake Certification Training

The Federal Railroad Administration (FRA) has approved Wabtec's training program as required by Title 49 Code of Federal Regulations (49 CFR) Part 243, training, qualification, and oversight for safety-related railroad employees.

Freight Car Air Brake Test in Compliance with S-486/S-4027

Certification training provided for both manual and automated single car testing focused on:

- Single Car Air Brake Component Identification and Function
- Daily Test, Single Car Test and Special Tests
- Review AAR S-486 Single Car Air Brake Test Procedures
- Hands-on Single Car Air Brake Test and Daily Test

Shoe Force Testing

Wabtec will provide test equipment and expertise to perform shoe force testing on customer equipment in full compliance with AAR Standard S-401.

M-214 Sideframe & Bolster Technical Service & Training

Includes a detailed review of Barber maintenance specifications, AAR M-214 requirements, interchange rules, hands-on inspection, and proper gauging.

Automated Single Car Test Device for 4-Port and traditional end of car testing.

The ASCTD offers significant time and cost savings compared to the traditional way single car tests are performed manually. It's scalable to accommodate future upgrades including ECP testing, and its fundamental accuracy in air brake testing improves the road reliability of every car tested.

Product Installation & Commissioning

- Pre-sale assistance with product selection to meet unique operational or regulatory requirements
- Product application assistance during railcar construction
- Commissioning support and testing as required for deployment into service
- Inspection and evaluation of sample cars

Service & Product Support

- Dedicated Technical Service & Support email WAB-TechService@wabtec.com is monitored by product specialists to assist
- Customer field assistance
- Routine repair shop, yard and ramp visits
- Follow-up evaluation of proposed maintenance
- Measurement and evaluation of car conversions
- Issue investigation & mitigation

Product Training

- Auto-rack equipment training for pre-trip, loading, and unloading ramp facilities
- On-site product training customized to meet customer needs

Wabtec Freight Car Components

Contact Information

Wabtec Corporation

30 Isabella Street
Pittsburgh, PA 15212 - USA

Customer Service

T. 412-825-1000, Option #1

E. freight.customerservice@wabtec.com

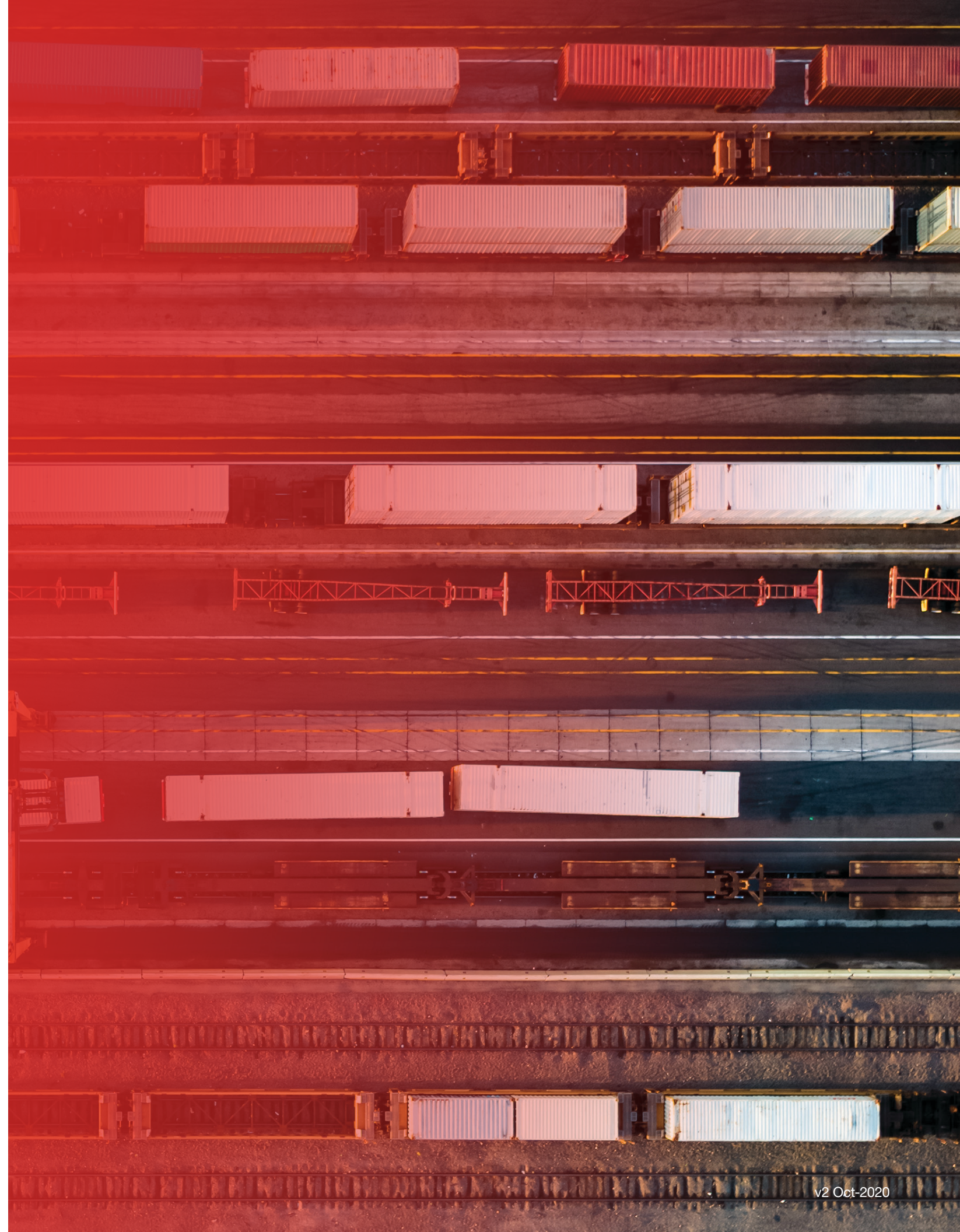



WabtecCorp.com